

Caseta cadru vertical

- Copertina verticala cu cadru este un sistem de protectie vertical, avand un plastic transparent gros de 0.8 mm, rezistent la ploie, zapada, vant etc. Se foloseste pentru inchiderea teraselor, foisoarelor de gradina, pereti despartitori la spalatoriile auto etc. Plasticul transparent se poate incadra intr-o caseta de aluminiu avand pe lateral, in interiorul aluminiului, perii ce asigura o etanseitate intre spatiul de afara si cel de interior.

Acoperirea suprafetelor verticale pentru a le proteja de expunerea la soare si la vant a dus la aparitia necesitatii unor sisteme autonome verticale de umbrire.

Aspectuos, discret, functional, cu posibilitate de utilizare a unei folii transparente, a unui voal perforat sau simplu ca mijloc de acoperire în functie de particularitatile spatiului.

Manual sau cu motor. Autonom sau in combinatie cu pergola. Oricum este folosita, aceasta constructie infrumusetaza spatiul, iar în combinatie cu pergola ofera o solutie completa de acoperire si protectie.

Cadrul, confectionat din profile de aluminiu cu perii protectoare, ofera o acoperire ideala si etansarea materialului de acoperire, a mecanismului sau a motorului, garantand buna functionare a constructiei.

Design-ul ingenios al ghidajelor din profile de aluminiu confera o protectie maxima impotriva vantului si ploii si creeaza pe de o parte (închis) iluzia spatiului inchis si pe de alta parte (deschis) confortul unei suprafete libere.

Ideal pentru cafenele, restaurante si orice spatiu exterior, dar si pentru ferestre ale cladirilor sau spatii semi-inchise.

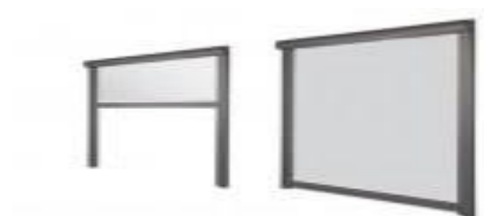



GOLD @en

5 years guarant

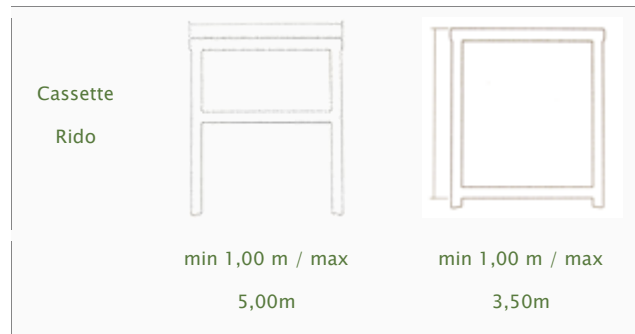
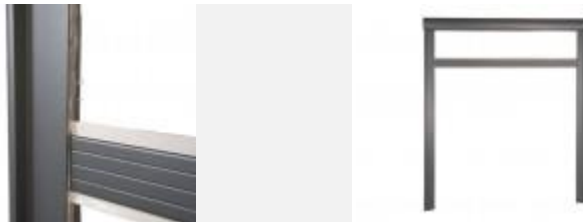

Informatii tehnice:

Pentru constructii manuale se foloseste un mecanism STAR 1/12 cu racord special lung.

Dimensiuni cadru: 140 mm x 140 mm.

Dimensiuni ghidaj: 120 mm x 60 mm, cu spatiu pentru fanta de ghidaj 30 mm

Dimensiuni contragreutate: 100mm x 18mm.



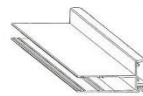
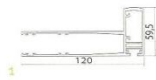
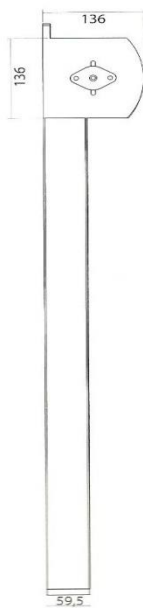

355201

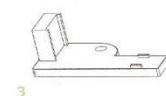

350214



355202



350215

ΤΕΧΝΙΚΕΣ ΛΕΠΤΟΜΕΡΙΕΣ - ΕΞΑΡΤΗΜΑΤΑ

1. Οδηγός Rido νέος, 2. Αντίβαρο νέου οδηγού Rido, 3. Βάση διαπέδου νέου οδηγού Rido,
4. Ζετ περίπου \varnothing 8x60 mm inox νέου οδηγού Rido. Find Technical details to parts section.

Produsul beneficiaza de marcaj



Statement of Compliance

Our Company,

C.H. FLOROS S.A.
located in 1 Menemenis Str, Tavros
Factory at Nea Zoi, Aspropyrgos

certifies that the assembled products of external shading:
Bracket type awnings 40x40, Cassette HORIZON,
Floper 100, Floper 120, Floper 160, Vertical Cassette Rido, Pergola Lydia
for external use in residential and commercial buildings
having the performance characteristics of product declared to
CE mark
comply with ΟΔΠ 89/106/ΕΟΚ, 2004/108/ΕΚ,
2006/95/ΕΚ and 98/37/ΕΚ
and the requirements of the harmonized standard

EN 13561:2004+A1:2008
Appendices: Β και ΖΑ
and
EN 60335-2-97 Appendix ΖΑ

Initial measurements were conducted on company premises

Date 25/02/2013

A handwritten signature in black ink, appearing to read 'Floros Stavros', is positioned above the printed name.

General Manager
FLOROS STAVROS